

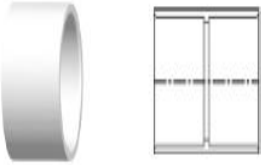









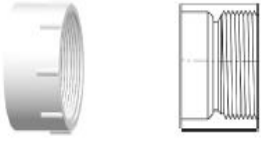

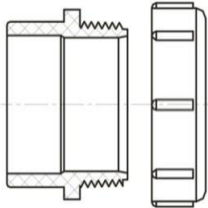

				
PVC0417	(718) 566 - 1000    www.alroproducts.com				
	Product(s)	Size(in)	Std Pk	Mstr Ctn	List Price
P9599	<b>Coupling (H × H)</b> 	1-1/4"	100	400	\$7.91
P9512		1-1/2"	100	400	\$1.64
P9513		2"	100	0	\$2.25
P9555		3"	60	0	\$7.84
P9514		4"	25	0	\$13.33
P10435		6"	5	0	\$42.08
		8"	8	0	\$73.04
		10"	8	0	\$175.60
		12"	2	0	\$299.00
		<b>Female Adapter (FPT × H)</b> 	1-1/4"	100	400
P9805	1-1/2"		100	400	\$3.13
P10072	2"		50	200	\$5.34
P10831	3"		35	0	\$14.24
P10797	4"		10	40	\$18.38
P10554	6"		10	0	\$59.32
	8"		9	0	\$130.99
	<b>Reducing Female Adapter(HxIPT)</b> 	1-1/2×1-1/4"	100	400	\$17.34
	<b>Pipe Increaser-Reducer (H × H)</b> 	1-1/2×1-1/4"	25	150	\$7.82
P9488		2×1-1/2"	25	100	\$5.02

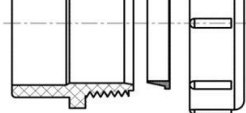
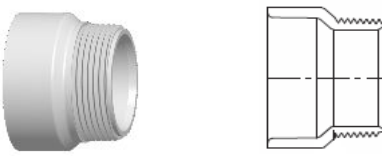
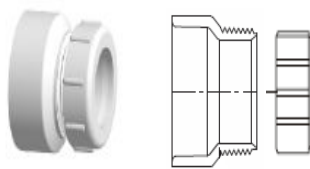
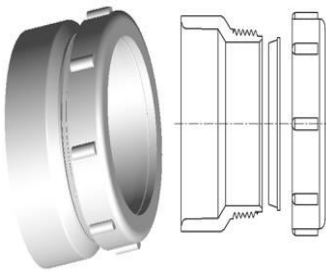
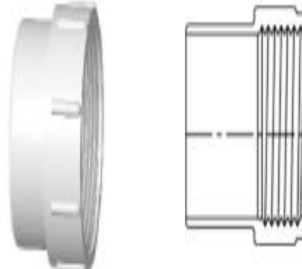
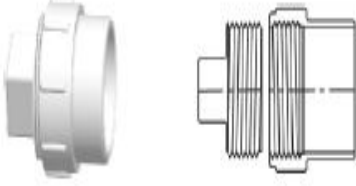
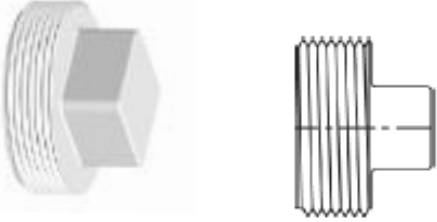
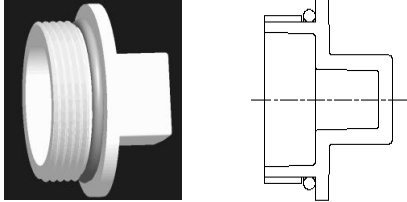

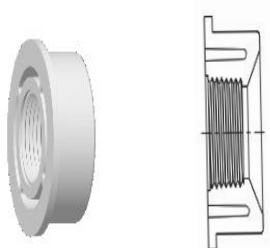
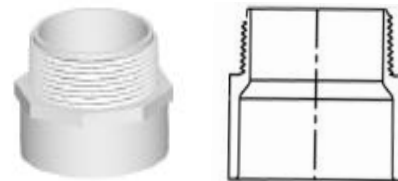
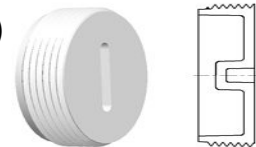
P10745		3×1-1/2"	25	0	\$14.72
P9671		3×2"	20	80	\$11.39
		4×1-1/2"	25	0	\$18.71
P9605		4×2"	10	40	\$22.45
P9672		4×3"	20	0	\$24.00
P9954		6×4"	6	0	\$93.35
		8×4"	12	0	\$129.93
		8×6"	12	0	\$104.47
		10×4"	12	0	\$247.77
		10×6"	12	0	\$359.20
		10×8"	10	0	\$263.42
		12x8"	2	0	\$460.90
		12×10"	2	0	\$483.94
		<b>Trap Adapter-Male (S × SLIP)</b>	1-1/4"	60	240
P9725		1-1/2"	50	200	\$6.09
		2"	25	150	\$19.60
		1-1/2×1-1/4"	50	200	\$6.31
	<b>Trap Adapter-Male w/Plastic Nut (S × SLIP)</b>	1-1/4"	30	180	\$6.45
		1-1/2"	50	300	\$6.09
		2"	25	100	\$19.60
		1-1/2×1-1/4"	75	300	\$6.31
	<b>TRAP ADAPTER-MALE W/1-1/2 PLASTIC NUT &amp; WASHER AND 1-1/2×1-1/4 WASHER (S × SLIP)</b>	1-1/2"	10	80	\$6.64
	<b>TRAP ADAPTER-MALE W/PLASTIC NUT &amp; WASHER (S × SLIP)</b>	1-1/4"	30	180	\$9.28
P9727		1-1/2"	50	300	\$6.19

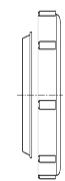

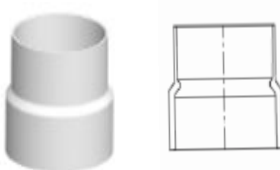
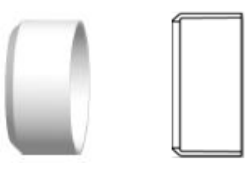
		2"	40	240	\$27.18
P10007		1-1/2x1-1/4"	50	300	\$7.03
	<b>Trap Adapter - Female ( H x SLIP)</b>	1-1/4"	50	300	\$5.78
		1-1/2"	50	200	\$5.19
		2"	50	200	\$17.61
		1-1/2x1-1/4"	50	200	\$6.66
	<b>Trap Adapter - Female w/Plastic Nut( H x SLIP)</b>	1-1/4"	50	300	\$6.61
		1-1/2"	50	300	\$5.94
		1-1/2x1-1/4"	50	300	\$6.19
		2"	50	200	\$9.90
	<b>TRAP ADAPTER - FEMALE W/PLASTIC NUT &amp; WASHER (H x SLIP)</b>	1-1/4"	50	300	\$6.61
		1-1/2"	50	200	\$5.94
		2"	50	200	\$9.90
		1-1/2x1-1/4"	50	300	\$6.19
	<b>Fitting Cleanout Adapter ( S x FPT)</b>	1-1/4"	35	210	\$5.32
P10097		1-1/2"	50	200	\$3.99
P10704		2"	50	200	\$5.11
		3"	20	80	\$14.33
P9747		4"	10	40	\$23.55

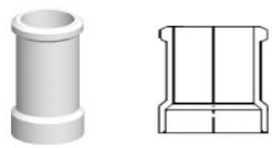
			6"	10	0	\$67.03
	<b>Fitting Cleanout Adapter w/ C.O. Plug (S × FPT)</b>		1-1/4"	50	200	\$7.23
			1-1/2"	50	200	\$6.90
			2"	50	200	\$8.39
			3"	20	80	\$20.23
			4"	10	40	\$32.20
			6"	6	0	\$94.13
P8563	<b>Cleanout Plug (MPT)</b>		1-1/4"	50	600	\$3.85
P10016			1-1/2"	50	300	\$2.95
P8651			2"	50	200	\$3.31
P9889			3"	25	150	\$5.91
P10051			4"	30	120	\$8.72
P9401			6"	10	40	\$27.85
			8"	5	20	\$106.92
	<b>Cleanout Plug w/Gasket (MPT)</b>		1-1/2"	100	600	\$4.47
			2"	50	200	\$4.96
			3"	25	150	\$8.88
			4"	25	100	\$13.09
			6"	10	40	\$43.54
P9847	<b>Flush Bushing (S × H)</b>		1-1/2×1-1/4"	100	400	\$6.58
			2×1-1/4"	50	200	\$7.56
P9729			2×1-1/2"	50	200	\$2.85
P9489			3×1-1/2"	30	120	\$13.78
P9490			3×2"	30	120	\$7.22
P9744			4×2"	30	0	\$23.97
P9719			4×3"	30	0	\$12.31
			6×3"	10	0	\$58.14
			6×4"	10	0	\$61.55

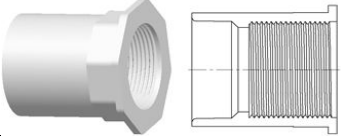
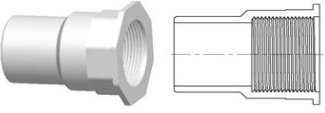
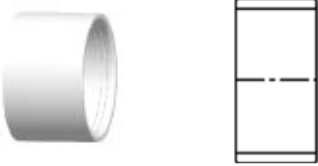
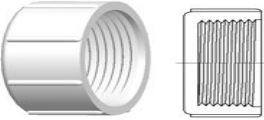
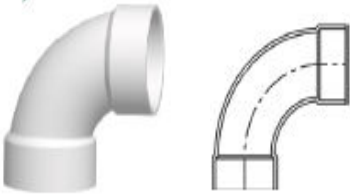
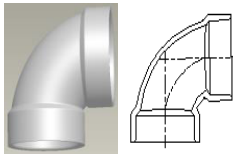

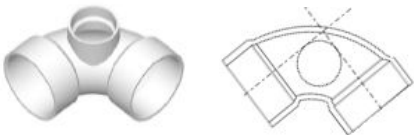
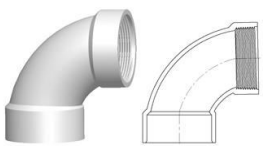
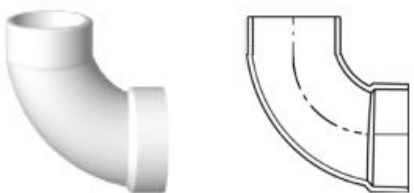
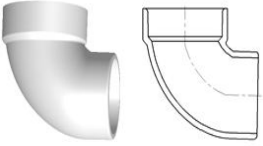
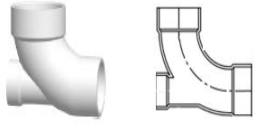
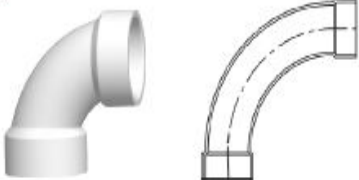

		8x4"	3	0	\$111.05	
		10x6"	12	0	\$243.43	
		12x6"	4	0	\$418.06	
		12x8"	4	0	\$438.95	
	<b>Reducer Bushing(Dishwasher Bushing) (S x FPT)</b>	1-1/2x1/2"	50	300	\$5.64	
		1-1/2x3/4"	50	300	\$7.51	
		1-1/2x1-1/4"	50	400	\$7.29	
		2x1-1/2"	50	200	\$16.45	
		3x1-1/2"	10	60	\$20.84	
		3x2"	10	60	\$20.84	
		10x8"	12	0	\$569.42	
		12x8"	4	0	\$827.19	
		<b>Male Adapter (MPT x H)</b>	1-1/4"	50	200	\$9.15
P9399			1-1/2"	50	300	\$3.15
P9849	2"		50	200	\$4.23	
P9421	3"		25	0	\$11.80	
P10796	4"		25	0	\$26.70	
	6"		7	0	\$80.39	
	1-1/4x1-1/2"		25	150	\$4.56	
	<b>Flush C.O. Plug(MPT)</b>		2"	50	400	\$10.74
			3"	25	150	\$12.50
		4"	25	150	\$12.63	
		<b>PLUG SLIP (S)</b>	1-1/2"	25	300	\$14.49
		2"	50	200	\$21.68	
		<b>TRAP ADAPTER CAP W/GASKET</b>	1-1/4"	50	200	\$8.58
		1-1/2"	50	200	\$6.34	



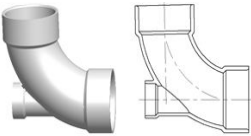
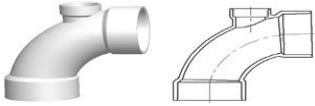

P9850	<b>Cap (SOC)</b> 	1-1/2"	20	240	\$6.66
P9852		2"	15	180	\$11.10
P9853		3"	10	60	\$18.58
P9692		4"	5	20	\$26.52
P11206		6"	8	0	\$66.97
		8"	16	0	\$180.01
		10"	16	0	\$225.39
		12"	4	0	\$285.13
		<b>Adapter Coupling (H x H)</b> 	3"	35	0
	4"		20	0	\$25.90
	4x3"		12	48	\$22.95
	<b>Adapter Coupling (S/D SxDWV H)</b>	4x3"	8	48	\$21.28
	<b>Adapter Bushing (DWV SPIGOT x HUB)</b> 	2"	25	300	\$6.17
		3"	25	150	\$22.73
		4"	10	60	\$9.92
		6"	12	0	\$21.75
	<b>No-Hub Adapter (S x H)</b> 	1-1/2"	25	100	\$21.75
		2"	25	100	\$8.69
		3"	20	80	\$12.61
		4"	14	56	\$16.20
		2x1-1/2"	25	100	\$26.52
		4x3"	8	48	\$28.84
	<b>Hub Adapter (HxS)</b> 	2"	20	80	\$16.47
		3"	20	0	\$31.24
P10028		4"	12	0	\$46.99

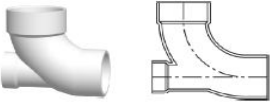
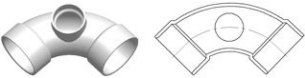
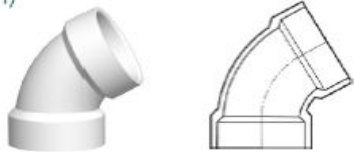

	<b>Trap Adapter Plug(H x NPSM Thread)</b> 	1-1/2"	20	80	\$9.15
	<b>Trap Adapter Plug( S x NPSM Thread)</b> 	1-1/2"	12	72	\$10.18
P10828	<b>Repair Coupling (H x H)</b> 	1-1/2"	100	400	\$9.07
P10099		2"	30	120	\$6.33
P10030		3"	10	60	\$16.01
		4"	5	30	\$30.80
		6"	12	0	\$137.68
	<b>Threaded Cap (FPT)</b> 	1-1/2"	50	400	\$7.24
		2"	35	210	\$10.07
		3"	30	120	\$48.42
P11234	<b>1/4 Bend (H x H)</b> 	1-1/4"	50	200	\$12.24
P9515		1-1/2"	100	0	\$3.50
P9388		2"	50	0	\$5.50
P9389		3"	25	0	\$16.17
P9516		4"	10	0	\$31.93
P11143		6"	4	0	\$107.92
		8"	4	0	\$145.63
	<b>90° Elbow-Short Turn (HxH)</b> 	1-1/2"	100	0	\$3.50
P10760		2"	25	100	\$5.50
P10761		3"	25	0	\$16.17
	<b>1/4 BEND, REDUCING (H x H)</b> 	2X1-1/2"	50	0	\$20.20

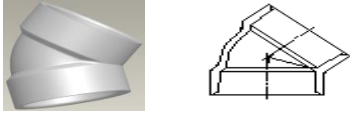
	<b>1/4 Bend with Side Inlet(ALL HUB)</b>		3x3x1-1/2"	8	0	\$44.57
P9491			3x3x2"	10	0	\$31.83
	<b>1/4 Bend(H x FIPT)</b>		3"	15	0	\$44.53
	<b>1/4 Bend, Street (S x H)</b>		1-1/4"	50	200	\$18.51
P9641			1-1/2"	30	180	\$4.52
P9601			2"	50	0	\$6.93
P9519			3"	20	0	\$17.48
P9521			4"	10	0	\$32.50
			6"	4	0	\$145.38
			8"	4	0	\$272.32
	<b>90°ELBOW-SHORT TURN (Hx S)</b>		2"	70	0	\$6.93
	<b>1/4 Bend w/ Low Heel Inlet (H x H x H)</b>		3x3x1-1/2"	25	0	\$32.97
P9492			3x3x2"	25	0	\$28.07
P9748			4x4x2"	6	0	\$55.41
	<b>Long Sweep 1/4 Bend (H x H)</b>		1-1/2"	30	120	\$8.10
P9522			2"	15	60	\$9.02
P9632			3"	10	0	\$20.78
P9523			4"	5	0	\$39.44
			6"	4	0	\$154.15
	<b>11-1/4° Elbow(H x H)</b>		6"	6	0	\$142.93

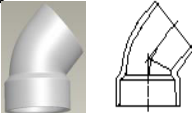

	<b>11-1/4° Elbow(S × H)</b> 	6"	5	0	\$139.84
	<b>Long Sweep 1/4 Bend w/Low Heel Inlet (All HUB)</b> 	3×3×1-1/2"	10	0	\$26.73
		3×3×2"	20	0	\$62.83
	<b>Long Sweep 1/4 Bend w/High Heel Inlet (All HUB)</b> 	3×3×2"	20	0	\$133.95
	<b>Long Sweep 1/4 Bend, Street (H × S)</b> 	1-1/2"	30	120	\$12.50
		2"	15	60	\$13.53
		3"	10	0	\$37.25
		4"	5	0	\$57.39
	<b>1/4 Bend, Street w/ Low Heel Inlet (H × S × H)</b> 	3×3×2"	15	0	\$80.27
	<b>Long Sweep 1/4 Bend w/Side Inlet (All×Hub)</b> 	3×3×2"	10	0	\$90.30
	<b>1/6 Bend (H × H)</b> 	1-1/2"	40	160	\$7.41
		2"	25	100	\$9.52
P9524		3"	20	0	\$29.94
P9526		4"	8	0	\$46.89
		6"	2	0	\$229.72
	<b>1/6 Bend, Street (H × S)</b> 	1-1/2"	40	160	\$14.85
		2"	25	100	\$19.14
		3"	20	0	\$41.27
P9528		4"	10	0	\$64.19
P11235	<b>1/8 Bend (H × H)</b>	1-1/4"	50	200	\$8.36
P9640		1-1/2"	100	0	\$3.42

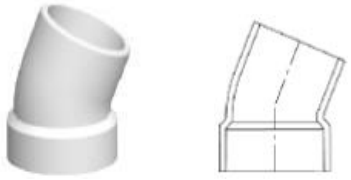
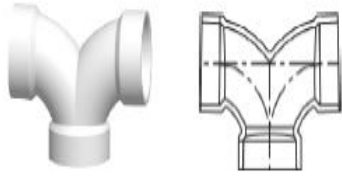
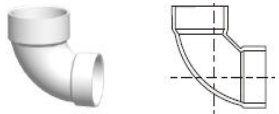
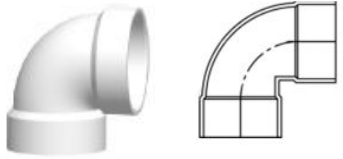
P9551		2"	50	0	\$5.09	
P9539		3"	25	0	\$14.48	
P9540		4"	15	0	\$25.39	
P11144		6"	5	0	\$98.77	
		8"	4	0	\$129.32	
	<b>45° Elbow-Short Turn (H×H)</b>					
		1-1/2"	60	240	\$3.42	
P11252	<b>1/8 Bend, Street (H × S)</b> 	1-1/4"	40	240	\$11.43	
P9602		1-1/2"	100	0	\$3.27	
P9552		2"	50	0	\$5.20	
P9554		3"	25	0	\$13.72	
P9541		4"	9	0	\$23.53	
P11233		6"	5	0	\$116.99	
		8"	4	0	\$140.35	
		10"	4	0	\$351.43	
		<b>45° Elbow-Short Turn (H×S)</b>				
			1-1/2"	80	320	\$3.27
P10393	<b>1/16 Bend (H × H)</b> 	1-1/2"	50	200	\$4.65	
P9718		2"	25	100	\$5.75	
P9604		3"	25	0	\$14.28	
P9606		4"	15	0	\$22.58	
		6"	3	0	\$130.40	
		8"	6	0	\$215.85	
		10"	4	0	\$336.43	
		12"	2	0	\$538.30	

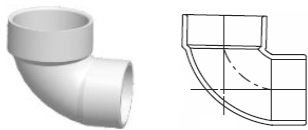
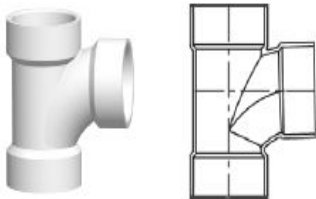
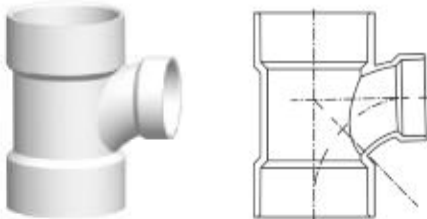
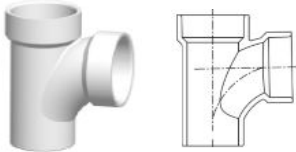

	<b>22.5° Elbow-Short Turn (H×H)</b>				
		1-1/2"	50	200	\$4.65
P9952	<b>1/16 Bend, Street (H × S)</b>	1-1/2"	50	200	\$13.16
P9603		2"	25	100	\$14.08
P9673		3"	25	0	\$22.13
P10817		4"	10	0	\$32.10
		6"	5	0	\$126.34
	<b>Double 1/4 Bend (H × H × H)</b>	1-1/2"	20	80	\$13.84
P10844		2"	25	0	\$18.89
		3"	15	0	\$49.33
		4"	6	0	\$77.60
		2×1-1/2×1-1/2"	15	60	\$17.39
P10691	<b>Closet Bend, Reducing (H × H)</b>	3×4"	10	0	\$26.00
					
	<b>Vent Ell (H × H)</b>	1-1/4"	30	120	\$23.74
P10843		1-1/2"	25	150	\$7.23
P10394		2"	30	120	\$9.39
P9493		3"	25	0	\$24.33
P9494		4"	10	0	\$57.86
		6"	4	0	\$182.42
	<b>Vent Ell, Street (H × S)</b>	1-1/4"	30	120	\$24.05
P10041		1-1/2"	25	150	\$7.31
P10040		2"	20	80	\$10.86
P9495		3"	25	0	\$29.13
P10009		4"	10	0	\$86.83

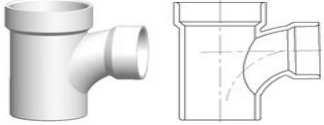
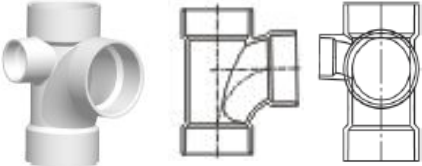
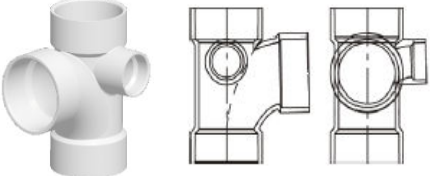
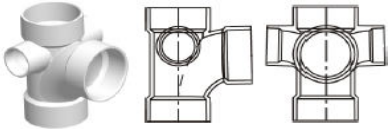
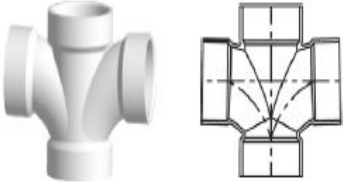
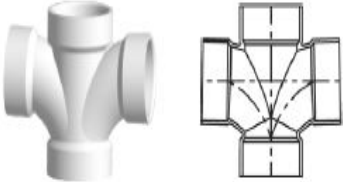
		6"	4	0	\$144.63
		10			\$380.62
	<b>Trap Elbow(for use with Traps only)(H × S)</b>				
		3"	30	0	\$25.98
		4"	20	0	\$83.27
	<b>Sanitary Tee (ALL HUB)</b>				
P9638		1-1/4"	50	0	\$13.13
P9390		1-1/2"	60	0	\$6.09
P9529		2"	35	0	\$8.97
P9530		3"	15	0	\$23.61
		4"	5	0	\$43.38
		6"	3	0	\$174.18
		8"	2	0	\$385.92
		<b>Reducing Sanitary Tee(ALL HUB)</b>			
P9637		1-1/2×1-1/2×1-1/4"	10	40	\$11.14
P9531		2×1-1/2×1-1/2"	15	60	\$7.90
P9953		2×2×1-1/2"	50	0	\$7.92
P9392		2×1-1/2×2"	15	60	\$9.58
P9532		3×3×1-1/2"	8	32	\$17.25
		3×3×2"	15	0	\$17.76
P9534		4×4×1-1/2"	10	0	\$45.48
P9535		4×4×2"	10	0	\$37.32
		4×4×3"	10	0	\$50.73
		6×6×2"	5	0	\$187.69
		6×6×3"	4	0	\$206.06
		6×6×4"	4	0	\$168.45
P10017		<b>Sanitary Tee, Street (S × H × H)</b>			
		1-1/2"	25	100	\$18.38
P10692		2"	30	0	\$17.83
		3"	10	0	\$29.72
P10019		4"	10	0	\$75.03

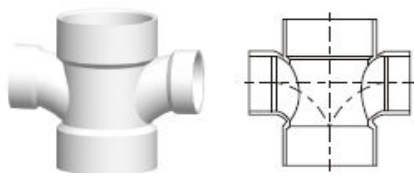
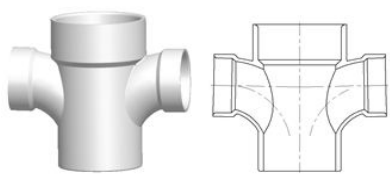
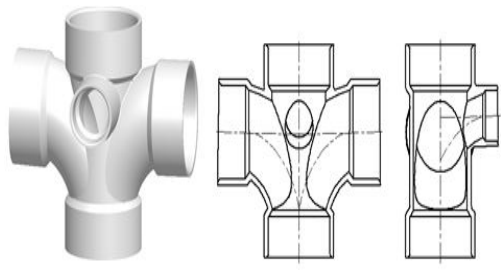
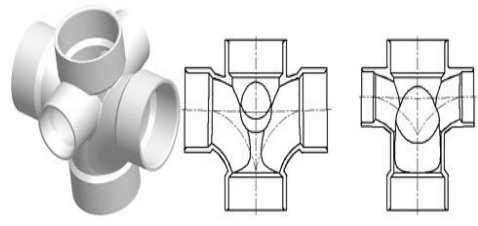
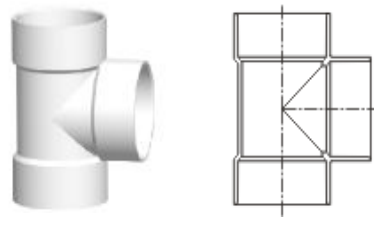
	<b>Sanitary Tee, Street, Reducing (S × H × H)</b>  	2×1-1/2×1-1/2"	50	0	\$15.28
		2×1-1/2×2"	15	60	\$14.01
		2×2×1-1/2"	15	60	\$15.70
		3×3×1-1/2"	9	36	\$34.19
		3×3×2"	15	0	\$29.35
		4×4×2"	10	0	\$55.77
	<b>Sanitary Tee w/ Left Side Inlet (ALL HUB)</b>  	3×3×3×1-1/2"	8	0	\$64.05
		3×3×3×2"	10	0	\$42.73
		4×4×4×2"	4	0	\$103.06
	<b>Sanitary Tee w/ Right Side Inlet (ALL HUB)</b>  	3×3×3×1-1/2"	10	0	\$61.95
		3×3×3×2"	12	0	\$42.73
		4×4×4×2"	8	0	\$103.06
	<b>Sanitary Tee w/ R &amp; L Side Inlets (ALL HUB)</b>  	3×3×3×1-1/2×1-1/2"	6	0	\$47.00
		3×3×3×2×2"	6	0	\$67.80
		4×4×4×2×2"	5	0	\$123.39
P10095	<b>Double Sanitary Tee (ALL HUB)</b>  	1-1/2"	15	60	\$13.50
P9971		2"	25	0	\$18.25
P10953		3"	6	0	\$51.02
P9906		4"	6	0	\$82.07
		6"	1	0	\$379.69
P10815	<b>Double Sanitary Tee, Reducing (ALL HUB)</b>  	2×2×1-1/2×1-1/2"	25	0	\$14.33
		3×3×2×1-1/2"	25	0	\$28.61
		3×3×1-1/2×1-1/2"	6	24	\$30.35

P9746		3×3×2×2"	10	0	\$32.73
		4×4×1-1/2×1-1/2"	7	0	\$109.57
P9693		4×4×2×2"	5	0	\$67.88
P10088		4×4×3×3"	5	0	\$70.43
		6×6×2×2"	4	0	\$271.89
		6×6×3×3"	4	0	\$284.85
P11231		6×6×4×4"	3	0	\$295.76
	<b>Double Sanitary Tee, Street, Reducing (S × H × H × H)</b>				
		3×3×2×2"	10	0	\$108.07
	<b>Double Sanitary Tee w/ Side Inlet (All HUB)</b>				
		3×3×3×3×1-1/2"	5	0	\$71.83
		3×3×3×3×2"	5	0	\$71.83
		4×4×4×4×2"	4	0	\$152.82
	<b>Double Sanitary Tee w/ R &amp; L Side Inlets (All HUB)</b>				
		3×3×3×3×2×2"	4	0	\$100.81
		4×4×4×4×2×2"	4	0	\$165.53
	<b>Vent Tee (ALL HUB)</b>				
		1-1/2"	25	100	\$22.80
		2"	25	0	\$18.68
		3"	10	0	\$54.42
		4"	5	0	\$74.57
		6"	3	0	\$149.35

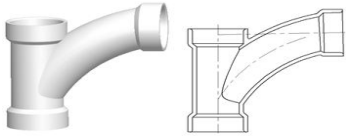
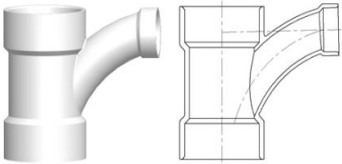
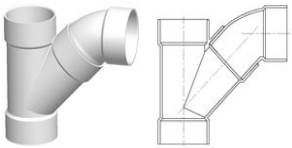
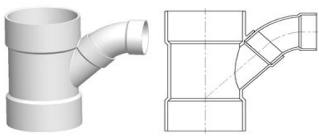

			8"	5	0	\$384.67
P10077	<b>Cleanout Tee w/ C.O. Plug (H x H)</b>		1-1/2"	20	80	\$15.38
P9674			2"	15	60	\$17.83
P9732			3"	20	0	\$34.11
P9735			4"	10	0	\$58.99
			6"	4	0	\$283.14
			8"	4	0	\$517.34
	<b>Flush C.O. Tee (H x H x FPT)</b>			1-1/2"	20	120
		2"		20	80	\$14.55
		3"		15	0	\$28.19
P11062		4"		10	0	\$50.32
		6"		6	0	\$253.03
		8"		4	0	\$415.15
	<b>Flush C.O. Tee w/C.O. Plug (H x H x FPT)</b>		2"	10	60	\$24.68
			3"	10	0	\$39.60
			4"			\$65.48
	<b>2-Way Cleanout (ALL HUB)</b>		3"	10	0	\$54.67
			4"	4	0	\$70.76
P10715	<b>Double Fixture Fitting (ALL HUB)</b>		2x2x2x2"	15	0	\$31.31
			3x3x3x3"	10	0	\$67.05
			2x1-1/2x1-1/2x1-1/2"	20	0	\$38.23
			2x2x1-1/2x1-1/2"	20	0	\$35.70
			2x1-1/2x2x2"	20	0	\$24.81



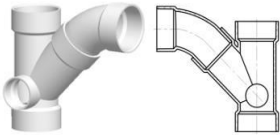
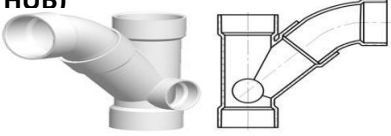
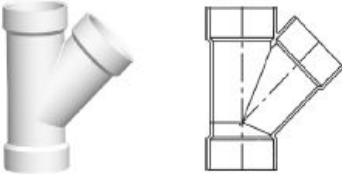
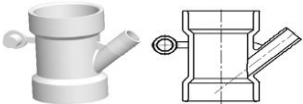
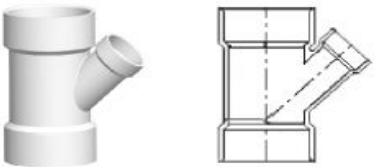

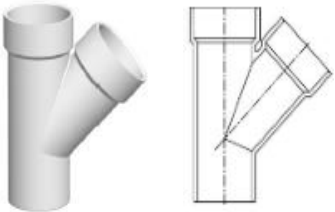
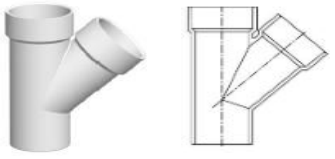
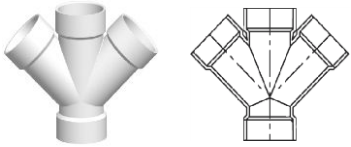
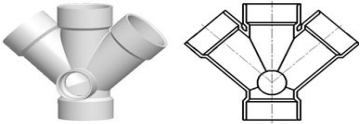
		3×2×3×3"	10	0	\$74.51	
	<b>Combination Wye and 1/8 Bend (One Piece) (All HUB)</b> 	1-1/2"	10	40	\$14.86	
		2"	20	0	\$15.80	
		3"	10	0	\$40.61	
		4"	4	0	\$80.48	
	<b>Combination Wye and 1/8 Bend, Reducing (One Piece) (All HUB)</b> 	2×1-1/2×1-1/2"	10	40	\$28.48	
		2×2×1-1/2"	10	40	\$20.89	
		2×1-1/2×2"	20	0	\$19.92	
		3×3×1-1/2"	12	0	\$37.25	
		3×3×2"	12	0	\$27.75	
		4×4×2"	6	0	\$42.05	
		4×4×3"	4	0	\$54.24	
	<b>Combination Wye and 1/8 Bend (Two Piece) (All HUB)</b> 	1-1/2"			\$13.34	
		2"				\$16.26
		3"	10	0		\$42.99
		4"	5	0		\$100.48
		6"	1	0		\$309.88
		8"				\$451.48
	<b>Combination Wye and 1/8 Bend, Reducing (Two Piece) (All HUB)</b> 	3x3x2"			\$43.47	
		4x4x3"				\$80.47
		6×6×4"	3	0		\$278.70
		8x8x3"				\$263.57
		8x8x6"				\$448.23
		10x10x4"				\$452.91
	<b>Combination Wye and 1/8 Bend Double Assembly (All HUB)</b> 	1-1/2"	10	0	\$47.19	
		2"	10	0	\$73.13	
		3"	6	0	\$104.15	
		4"	3	0	\$210.81	

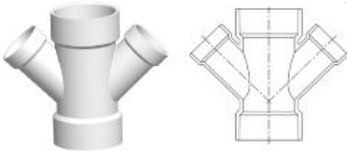
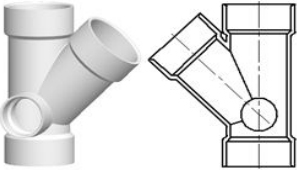
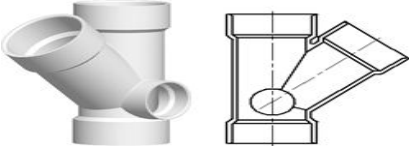



		2x1-1/2"	30	0	\$70.40
P11260		3x2"	10	0	\$119.23
		4x2"	5	0	\$222.25
		4x3"	5	0	\$194.50
	<b>Combination Wye and 1/8 Bend w/Left Side Inlet (All HUB)</b> 	3x3x3x2"	8	0	\$120.52
	<b>Combination Wye and 1/8 Bend w/Right Side Inlet (All HUB)</b> 	3x3x3x2"	8	0	\$120.52
	<b>Wye (ALL HUB)</b> 	1-1/4"	25	100	\$16.76
P9639		1-1/2"	50	0	\$11.16
P9553		2"	25	0	\$10.93
P9497		3"	15	0	\$29.49
P9498		4"	8	0	\$53.65
P11232		6"	2	0	\$155.76
		8"	2	0	\$274.63
P10027	<b>Dishwasher Wye (H x H x Hose Barb)</b> 	1-1/2"x1-1/2"x1/2"	40	160	\$2.95
	<b>Reducing Wye (ALL HUB)</b> 	2x1-1/2x1-1/2"	15	60	\$15.38
P10020		2x2x1-1/2"	15	60	\$13.44
		2x1-1/2x2"	10	40	\$23.81
P9784		3x3x1-1/2"	15	0	\$19.89
P9636		3x3x2"	12	0	\$21.82
P10100		4x4x1-1/2"	10	0	\$68.80
P9537		4x4x2"	10	0	\$32.30
P9538		4x4x3"	10	0	\$43.55

		6×6×2"	5	0	\$163.71
		6×6×3"	3	0	\$151.33
P11357		6×6×4"	4	0	\$118.38
		8×8×4"	4	0	\$242.28
		8×8×6"	2	0	\$258.73
		10×10×4"	4	0	\$345.49
	<b>Wye, Street(S × H × H)</b>	1-1/2"	50	0	\$20.70
		2"	10	40	\$19.85
		3"	10	0	\$43.20
		4"	8	0	\$88.47
		<b>Wye, Street, Reducing(S × H × H)</b>	2×2×1-1/2"	15	60
		3×3×1-1/2"	15	0	\$48.49
		3×3×2"	8	0	\$33.95
		4×4×2"	5	0	\$100.99
		4×4×3"	5	0	\$94.10
P11324		<b>Double Wye (ALL HUB)</b>	1-1/2"	40	0
P10870		2"	20	0	\$28.07
P9907		3"	8	0	\$58.32
P10762		4"	5	0	\$118.30
		6"	1	0	\$234.97
		<b>Double Wye, w/2" Side Inlet (ALL HUB)</b>	3"×3"×3"×3"×2"	10	0
					
P10816		<b>Reducing Double Wye(ALL HUB)</b>	2×2×1-1/2×1-1/2"	10	40
		3×3×1-1/2×1-1/2"	10	0	\$51.07

P10680		3×3×2×2"	15	0	\$43.47	
P9745		4×4×2×2"	6	0	\$70.94	
P11372		4×4×3×3"	5	0	\$93.69	
		6×6×2×2"	4	0	\$222.77	
		6×6×3×3"	3	0	\$230.59	
		6×6×4×4"	3	0	\$328.76	
		<b>Wye w/Left Side Inlet (All HUB)</b>				
		3×3×3×2"	18	0	\$134.64	
		4×4×4×2"	4	0	\$179.40	
	<b>Wye w/Right Side Inlet (All HUB)</b>					
		3×3×3×2"	6	0	\$134.64	
		4×4×4×2"	3	0	\$179.40	
	<b>Adapter, Tail Piece w/Plastic Nut (S x SLIP)</b>					
		1-1/2"	24	144	\$6.65	
		1-1/2×1-1/4"	20	120	\$6.65	
P10738		<b>Return Bend (H × H)</b>	1-1/2"	20	80	\$10.49
P11118		2"	25	0	\$18.03	
P9884		3"	8	0	\$55.93	
P10822		4"	6	0	\$101.58	
		6"	2	0	\$218.25	
P9882		<b>P-Trap (H × H)</b>	1-1/2"	25	0	\$11.72
P9642		2"	15	0	\$15.76	
P9691		3"	10	0	\$53.61	
P10673		4"	4	0	\$121.53	
		6"	1	0	\$377.64	

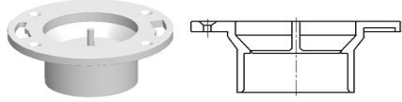
P10021	<b>P-Trap w/ Cleanout (H x H)</b> 	1-1/2"	30	0	\$19.92
P10022		2"	20	0	\$32.65
	<b>Adjustable P-Trap w/ Plastic Nut (H x H)</b> 	1-1/4"	30	0	\$86.01
P9626		1-1/2"	30	0	\$15.52
P9625		2"	20	0	\$32.35
	<b>P-TRAP W/UNION JOINT(H X FPT)</b> 	1-1/2"	30	0	\$15.52
	<b>P-Trap ,Low Profile(H x H)</b> 	1-1/2"	25	0	\$7.45
		2"	15	0	\$13.38
		3"	10	0	\$53.69
		4"	4	0	\$122.47
		6"	1	0	\$377.64
P9957	<b>L.A. Pattern P-Trap ,w/Union &amp; 1-1/2 &amp; 1-1/4 SLIP Washers ,w/Plastic Nut (SLIPxH)</b>	1-1/4x1-1/2"	30	0	\$26.16
P9987		1-1/2"	30	0	\$26.60
	<b>P-Trap(H x SLIP)</b>	1-1/2"	25	0	\$23.94
	<b>WASHER BOX P-TRAP (H X H)</b> 	2"	20	0	\$15.48

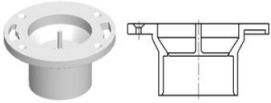
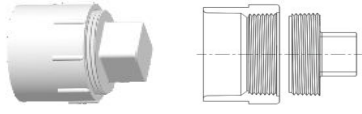
	<b>Closet Flange (H)</b>		4x4"	30	0	\$16.53
P10008			4x3"	25	0	\$16.33
	<b>Closet Flange (H) w/Test Plate</b>		4x3"	20	0	\$15.91
P10696	<b>Closet Flange, Reducing (SPIGOT)</b>		4x3"	25	0	\$16.92
	<b>CLOSET FLANGE W/ ADJUSTABLE PLASTIC RING (S)</b>		4x3"	25	0	\$51.00
	<b>Closet Flange(FPT)</b>		4x3"	20	0	\$22.34
	<b>Closet Flange (MPT)</b>		4x3"	25	0	\$17.13
	<b>Tube End Cleanout w/ C.O. Plug (H x FPT)</b>		1-1/2"	25	150	\$5.87
			2"	25	100	\$8.24
			3"	20	80	\$15.19
			4"	24	0	\$31.57