

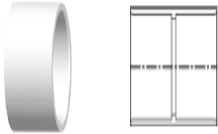

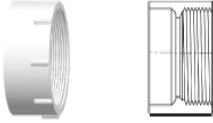

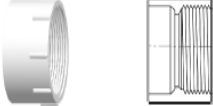





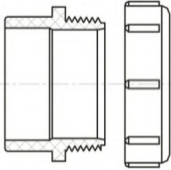
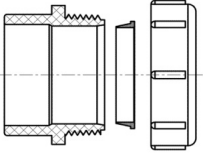

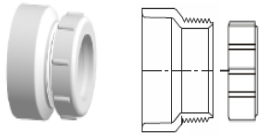
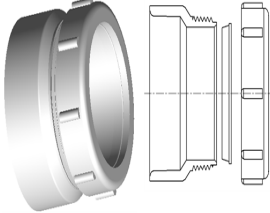
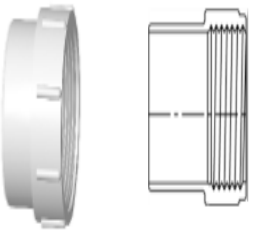
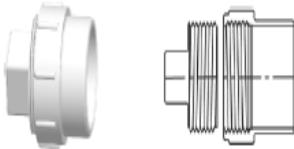
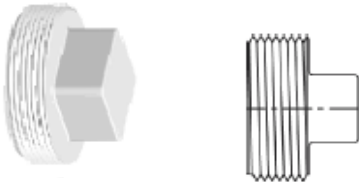
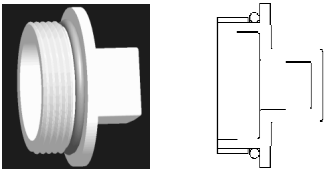

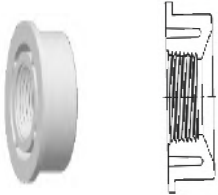
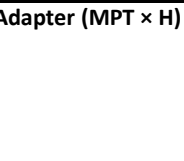

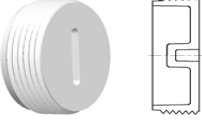
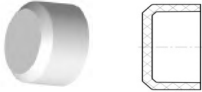
PVC DWV 011521	 (718) 566 - 1000 www.alroproducts.com					
	Product(s)	Part Number	Size(in)	Std Pk	Mstr Ctn	List Price
P9599	Coupling (H x H) 	LP100-012	1-1/4"	100	400	\$13.84
P9512		LP100-015	1-1/2"	100	400	\$2.87
P9513		LP100-020	2"	100	0	\$3.95
P9555		LP100-030	3"	60	0	\$13.71
P9514		LP100-040	4"	25	0	\$23.32
P10435		LP100-060	6"	5	0	\$73.52
P11483		LP100-080	8"	8	0	\$127.76
		LP100-100	10"	8	0	\$306.77
		LP100-120	12"	2	0	\$522.34
		Female Adapter (FPT x H) 	LP101-012	1-1/4"	100	400
P9805	LP101-015		1-1/2"	100	400	\$5.47
P10072	LP101-020		2"	50	200	\$9.34
P10831	LP101-030		3"	35	0	\$24.91
P10797	LP101-040		4"	10	40	\$32.15
P10554	LP101-060		6"	10	0	\$103.76
	LP101-080		8"	9	0	\$229.12
	Reducing Female Adapter(HxFPT) 		LP101-212	1-1/2x1-1/4"	100	400
	Pipe Increaser-Reducer (H x H) 	LP102-212	1-1/2x1-1/4"	25	150	\$13.67
P9488		LP102-251	2x1-1/2"	25	100	\$8.80
P10745		LP102-337	3x1-1/2"	25	0	\$25.75
P9671		LP102-338	3x2"	20	80	\$19.92
		LP102-419	4x1-1/2"	25	0	\$32.69
		LP102-420	4x2"	10	40	\$39.28

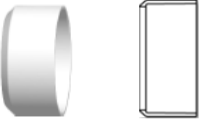

P9672		LP102-422	4×3"	20	0	\$41.99
P9954		LP102-532	6×4"	6	0	\$163.29
		LP102-582	8×4"	12	0	\$227.27
		LP102-585	8×6"	12	0	\$182.73
		LP102-624	10×4"	12	0	\$432.84
		LP102-626	10×6"	12	0	\$627.50
		LP102-628	10×8"	10	0	\$460.18
		LP102-668	12×8"	2	0	\$805.17
		LP102-670	12×10"	2	0	\$845.42
P11464	Trap Adapter-Male (S × SLIP) 	LP103-012	1-1/4"	60	240	\$11.27
P9725		LP103-015	1-1/2"	50	200	\$10.64
		LP103-020	2"	25	150	\$34.24
		LP103-212	1-1/2×1-1/4"	50	200	\$11.03
	Trap Adapter-Male w/Plastic Nut (S × SLIP) 	LP103P-012	1-1/4"	30	180	\$11.27
P9487		LP103P-015	1-1/2"	50	300	\$10.65
P10107		LP103P-020	2"	25	100	\$34.24
P10868		LP103P-212	1-1/2×1-1/4"	75	300	\$11.03
	TRAP ADAPTER-MALE W/1-1/2 PLASTIC NUT & WASHER AND 1-1/2×1-1/4 WASHER (S × SLIP)	LP103R-015	1-1/2"	10	80	\$11.60
P10093	TRAP ADAPTER-MALE W/PLASTIC NUT & WASHER (S × SLIP) 	LP103X-012	1-1/4"	30	180	\$16.22
P10879		LP103X-015	1-1/2"	50	300	\$10.82
		LP103X-020	2"	40	240	\$47.55
P10007		LP103X-212	1-1/2×1-1/4"	50	300	\$12.30
	Trap Adapter - Female (H × SLIP) 	LP104-012	1-1/4"	50	300	\$10.10
P9727		LP104-015	1-1/2"	50	200	\$9.09
		LP104-020	2"	50	200	\$30.77
		LP104-212	1-1/2×1-1/4"	50	200	\$11.65



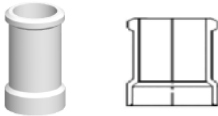
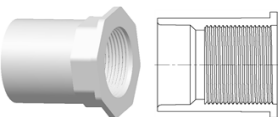
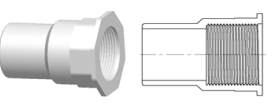
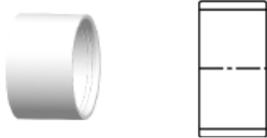

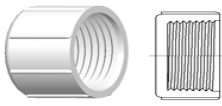
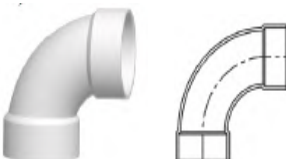

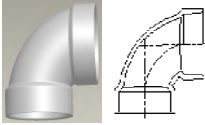
	Trap Adapter - Female w/Plastic Nut (H × SLIP) 	LP104P-012	1-1/4"	50	300	\$11.55
P9891		LP104P-015	1-1/2"	50	300	\$10.38
P10013		LP104P-212	1-1/2×1-1/4"	50	300	\$10.82
		LP104P-020	2"	50	200	\$17.30
	TRAP ADAPTER - FEMALE W/PLASTIC NUT & WASHER (H × SLIP) 	LP104X-012	1-1/4"	50	300	\$11.58
P10736		LP104X-015	1-1/2"	50	200	\$10.40
		LP104X-020	2"	50	200	\$17.30
		LP104X-212	1-1/2×1-1/4"	50	300	\$10.84
	Fitting Cleanout Adapter (S × FPT) 	LP105-012	1-1/4"	35	210	\$9.31
P10097		LP105-015	1-1/2"	50	200	\$6.98
P10704		LP105-020	2"	50	200	\$8.93
		LP105-030	3"	20	80	\$25.06
P9747		LP105-040	4"	10	40	\$41.19
		LP105-060	6"	10	0	\$117.26
	Fitting Cleanout Adapter w/ C.O. Plug (S × FPT) 	LP105X-012	1-1/4"	50	200	\$12.64
P10701		LP105X-015	1-1/2"	50	200	\$12.07
P10011		LP105X-020	2"	50	200	\$14.68
P10014		LP105X-030	3"	20	80	\$35.39
P9993		LP105X-040	4"	10	40	\$56.34
P11870		LP105X-060	6"	6	0	\$164.64
	Cleanout Plug (MPT) 	LP106-012	1-1/4"	50	600	\$6.73
P8563		LP106-015	1-1/2"	50	300	\$5.18
P10016		LP106-020	2"	50	200	\$5.79
P8651		LP106-030	3"	25	150	\$10.35
P9889		LP106-040	4"	30	120	\$15.25
P10051		LP106-060	6"	10	40	\$48.72
P9401						

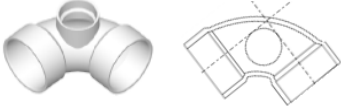
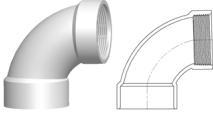
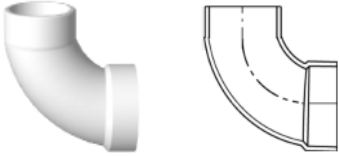
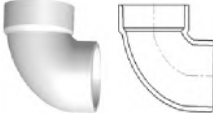
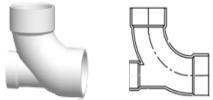
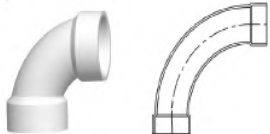



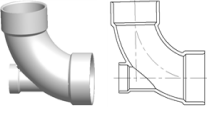
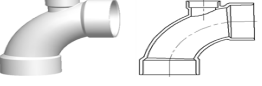

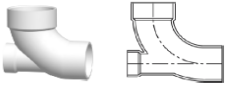
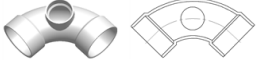
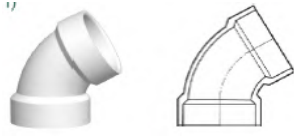
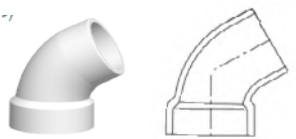

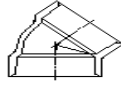

		LP106-080	8"	5	20	\$186.79
	Cleanout Plug w/Gasket (MPT) 	LP106R-015	1-1/2"	100	600	\$7.82
		LP106R-020	2"	50	200	\$8.67
		LP106R-030	3"	25	150	\$15.52
		LP106R-040	4"	25	100	\$22.87
		LP106R-060	6"	10	40	\$76.06
P9847	Flush Bushing (S x H) 	LP107-212	1-1/2x1-1/4"	100	400	\$11.51
		LP107-250	2x1-1/4"	50	200	\$13.23
P9729		LP107-251	2x1-1/2"	50	200	\$4.99
P9489		LP107-337	3x1-1/2"	30	120	\$24.11
P9490		LP107-338	3x2"	30	120	\$12.62
P9744		LP107-420	4x2"	30	0	\$41.92
P9719		LP107-422	4x3"	30	0	\$21.53
		LP107-530	6x3"	10	0	\$101.57
P12557		LP107-532	6x4"	10	0	\$107.66
		LP107-582	8x4"	3	0	\$194.24
		LP107-585	8x6"	0	3	\$210.76
		LP107-626	10x6"	12	0	\$381.03
		LP107-628	10x8"	0	9	\$392.67
		LP107-666	12x6"	4	0	\$654.37
		LP107-668	12x8"	4	0	\$687.08
	Reducer Bushing(Dishwasher Bushing) (S x FPT) 	LP108-209	1-1/2x1/2"	50	300	\$9.86
		LP108-210	1-1/2x3/4"	50	300	\$13.13
		LP108-212	1-1/2x1-1/4"	50	400	\$12.74
		LP108-251	2x1-1/2"	50	200	\$28.78
		LP108-337	3x1-1/2"	10	60	\$36.41
		LP108-338	3x2"	10	60	\$36.41
		LP108-628	10x8"	12	0	\$994.73
		LP108-668	12x8"	4	0	\$1,445.06
	Male Adapter (MPT x H) 	LP109-012	1-1/4"	50	200	\$16.01
P9399		LP109-015	1-1/2"	50	300	\$5.51
P9849		LP109-020	2"	50	200	\$7.40

P9421		LP109-030	3"	25	0	\$20.63
P10796		LP109-040	4"	25	0	\$46.71
		LP109-060	6"	7	0	\$140.44
		LP109-169	1-1/4×1-1/2"	25	150	\$7.97
	Flush C.O. Plug(MPT) 	LP110-020	2"	50	400	\$18.79
		LP110-030	3"	25	150	\$21.86
		LP110-040	4"	25	150	\$22.09
	PLUG SLIP (S) 	LP110S-015	1-1/2"	25	300	\$25.32
		LP110S-020	2"	50	200	\$37.88
	TRAP ADAPTER CAP W/GASKET 	LP114-012	1-1/4"	50	200	\$14.99
		LP114-015	1-1/2"	50	200	\$11.08
P9850	Cap (SOC) 	LP116-015	1-1/2"	20	240	\$11.65
P9852		LP116-020	2"	15	180	\$19.43
P9853		LP116-030	3"	10	60	\$32.50
P9692		LP116-040	4"	5	20	\$46.39
P11206		LP116-060	6"	8	0	\$117.13
		LP116-080	8"	16	0	\$314.87
		LP116-100	10"	16	0	\$393.75
		LP116-120	12"	4	0	\$498.11
		Adapter Coupling (H × H) 	LP117-030	3"	35	0
	LP117-040		4"	20	0	\$45.25
	LP117-422		4×3"	12	48	\$40.16
	Adapter Coupling (S/D S×DWV H)	LP117X-422	4×3"	8	48	\$37.22
	Adapter Bushing (DWV SPIGOT × HUB) 	LP118-020	2"	25	300	\$10.78
		LP118-030	3"	25	150	\$39.75
		LP118-040	4"	10	60	\$17.36
		LP118-060	6"	12	0	\$38.00
	No-Hub Adapter (S × H)	LP119-015	1-1/2"	25	100	\$38.05
		LP119-020	2"	25	100	\$15.21

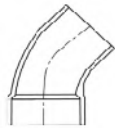

		LP119-030	3"	20	80	\$22.07
		LP119-040	4"	14	56	\$28.35
		LP119-251	2×1-1/2"	25	100	\$46.39
		LP119-422	4×3"	8	48	\$50.46
	Hub Adapter (H×S) 	LP123-020	2"	20	80	\$28.78
		LP123-030	3"	20	0	\$54.58
P10028		LP123-040	4"	12	0	\$82.09
	Trap Adapter Plug(H x NPSM Thread) 	LP128-015	1-1/2"	20	80	\$15.99
	Trap Adapter Plug(S x NPSM Thread) 	LP129-015	1-1/2"	12	72	\$17.79
P10828	Repair Coupling (H × H) 	LP130-015	1-1/2"	100	400	\$15.87
P10099		LP130-020	2"	30	120	\$11.07
P10030		LP130-030	3"	10	60	\$28.01
P11873		LP130-040	4"	5	30	\$53.87
		LP130-060	6"	12	0	\$240.83
	Test Cap (S) 	LP131-015	1-1/2"	100	600	\$6.52
		LP131-020	2"	100	600	\$6.87
		LP131-030	3"	50	200	\$7.10
		LP131-040	4"	100	400	\$8.89
	Threaded Cap (FPT) 	LP135-015	1-1/2"	50	400	\$12.65
		LP135-020	2"	35	210	\$17.60
		LP135-030	3"	30	120	\$84.59
P11234	1/4 Bend (H × H) 	LP300-012	1-1/4"	50	200	\$21.42
P9515		LP300-015	1-1/2"	100	0	\$6.13
P9388		LP300-020	2"	50	0	\$9.62
P9389		LP300-030	3"	25	0	\$28.29
P9516		LP300-040	4"	10	0	\$55.85
P11143		LP300-060	6"	4	0	\$188.53

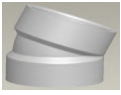
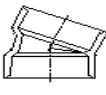
P11482		LP300-080	8"	4	0	\$254.72
	90° Elbow-Short Turn (H×H) 	LP300-015S	1-1/2"	100	0	\$6.12
P10760		LP300-020S	2"	25	100	\$9.61
P10761		LP300-030S	3"	25	0	\$28.25
	1/4 BEND, REDUCING (H × H) 	LP300R-251	2X1-1/2"	50	0	\$35.35
	1/4 Bend with Side Inlet(ALL HUB) 	LP300S-337	3×3×1-1/2"	8	0	\$77.87
P9491		LP300S-338	3×3×2"	10	0	\$55.68
	1/4 Bend(H x FIPT) 	LP301-030	3"	15	0	\$77.80
	1/4 Bend, Street (S × H) 	LP302-012	1-1/4"	50	200	\$32.39
P9641		LP302-015	1-1/2"	30	180	\$7.92
P9601		LP302-020	2"	50	0	\$12.14
P9519		LP302-030	3"	20	0	\$30.54
P9521		LP302-040	4"	10	0	\$56.86
P11655		LP302-060	6"	4	0	\$254.29
		LP302-080	8"	4	0	\$476.32
	90° ELBOW-SHORT TURN (H× S) 	LP302-020S	2"	70	0	\$12.11
	1/4 Bend w/ Low Heel Inlet (H × H × H) 	LP303-337	3×3×1-1/2"	25	0	\$57.60
P9492		LP303-338	3×3×2"	25	0	\$49.10
P9748		LP303-420	4×4×2"	6	0	\$96.93
	Long Sweep 1/4 Bend (H × H) 	LP304-015	1-1/2"	30	120	\$14.18
P9522		LP304-020	2"	15	60	\$15.78
P9632		LP304-030	3"	10	0	\$36.36
P9523		LP304-040	4"	5	0	\$69.00
		LP304-060	6"	4	0	\$269.63

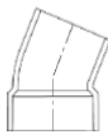
	11-1/4° Elbow(H × H) 	LP305-060	6"	6	0	\$249.69
	11-1/4° Elbow(S × H) 	LP306-060	6"	5	0	\$244.30
	Long Sweep 1/4 Bend w/Low Heel Inlet (All HUB) 	LP307-337	3×3×1-1/2"	10	0	\$46.70
		LP307-338	3×3×2"	20	0	\$109.91
	Long Sweep 1/4 Bend w/High Heel Inlet (All HUB) 	LP308-338	3×3×2"	20	0	\$234.01
	Long Sweep 1/4 Bend, Street (H × S) 	LP309-015	1-1/2"	30	120	\$21.86
		LP309-020	2"	15	60	\$23.64
		LP309-030	3"	10	0	\$65.16
		LP309-040	4"	5	0	\$100.38
	1/4 Bend, Street w/ Low Heel Inlet (H × S × H) 	LP310-338	3×3×2"	15	0	\$140.42
	Long Sweep 1/4 Bend w/Side Inlet (All×Hub) 	LP311-338	3×3×2"	10	0	\$157.94
	1/6 Bend (H × H) 	LP319-015	1-1/2"	40	160	\$12.95
		LP319-020	2"	25	100	\$16.66
P9524		LP319-030	3"	20	0	\$52.31
P9526		LP319-040	4"	8	0	\$82.01
		LP319-060	6"	2	0	\$401.30
	1/6 Bend, Street (H × S) 	LP320-015	1-1/2"	40	160	\$25.99
		LP320-020	2"	25	100	\$33.48
		LP320-030	3"	20	0	\$72.20
P9528		LP320-040	4"	10	0	\$112.28
P11235	1/8 Bend (H × H) 	LP321-012	1-1/4"	50	200	\$14.64
P9640		LP321-015	1-1/2"	100	0	\$5.99
P9551		LP321-020	2"	50	0	\$8.92

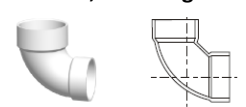
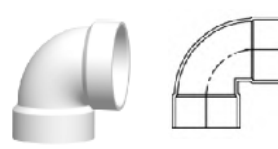
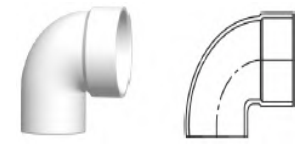
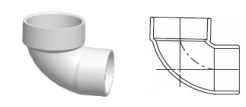
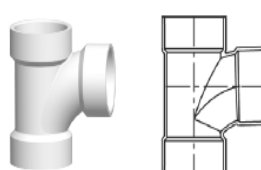
P9539			LP321-030	3"	25	0	\$25.33
P9540			LP321-040	4"	15	0	\$44.36
P11144			LP321-060	6"	5	0	\$172.77
			LP321-080	8"	4	0	\$226.20
	45° Elbow-Short Turn (H×H)		LP321-015S	1-1/2"	60	240	\$5.98
							
P11252	1/8 Bend, Street (H × S)		LP323-012	1-1/4"	40	240	\$20.00
P9602			LP323-015	1-1/2"	100	0	\$5.73
P9552			LP323-020	2"	50	0	\$9.10
P9554			LP323-030	3"	25	0	\$24.00
P9541			LP323-040	4"	9	0	\$41.16
P11233			LP323-060	6"	5	0	\$204.63
			LP323-080	8"	4	0	\$245.50
			LP323-100	10"	4	0	\$613.93
	45° Elbow-Short Turn (H×S)		LP323-015S	1-1/2"	80	320	\$5.72
							
P10393	1/16 Bend (H × H)		LP324-015	1-1/2"	50	200	\$8.13
P9718			LP324-020	2"	25	100	\$10.07
P9604			LP324-030	3"	25	0	\$24.99
P9606			LP324-040	4"	15	0	\$39.50
			LP324-060	6"	3	0	\$228.09
			LP324-080	8"	6	0	\$377.55
			LP324-100	10"	4	0	\$587.73
			LP324-120	12"	2	0	\$940.38
	22.5° Elbow-Short Turn (H×H)		LP324-015S	1-1/2"	50	200	\$8.13
							
P9952	1/16 Bend, Street (H × S)		LP326-015	1-1/2"	50	200	\$23.02
P9603			LP326-020	2"	25	100	\$24.63
P9673			LP326-030	3"	25	0	\$38.70
P10817			LP326-040	4"	10	0	\$56.16

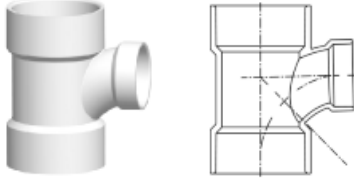
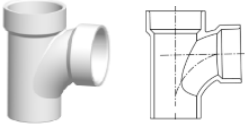
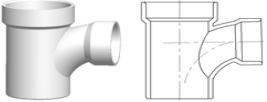
		LP326-060	6"	5	0	\$220.99
	Double 1/4 Bend (H × H × H) 	LP327-015	1-1/2"	20	80	\$24.21
P10844		LP327-020	2"	25	0	\$33.04
		LP327-030	3"	15	0	\$86.29
		LP327-040	4"	6	0	\$135.57
		LP327-241	2×1-1/2×1-1/2"	15	60	\$30.42
P10691	Closet Bend, Reducing (H × H) 	LP329-342	3×4"	10	0	\$45.48
	Vent Ell (H × H) 	LP331-012	1-1/4"	30	120	\$41.48
P10843		LP331-015	1-1/2"	25	150	\$12.65
P10394		LP331-020	2"	30	120	\$16.43
P9493		LP331-030	3"	25	0	\$42.56
P9494		LP331-040	4"	10	0	\$101.08
		LP331-060	6"	4	0	\$318.68
	Vent Ell, Street (H × S) 	LP333-012	1-1/4"	30	120	\$42.02
P10041		LP333-015	1-1/2"	25	150	\$12.78
P10040		LP333-020	2"	20	80	\$19.01
P9495		LP333-030	3"	25	0	\$50.95
P10009		LP333-040	4"	10	0	\$151.69
		LP333-060	6"	4	0	\$252.66
		LP333-080	8"	0	4	\$615.16
		LP333-100	10"	0	0	\$664.92
	Trap Elbow (for use with Traps only)(H × S) 	LP335-030	3"	30	0	\$45.39
		LP335-040	4"	20	0	\$145.47
	Sanitary Tee (ALL HUB) 	LP400-012	1-1/4"	50	0	\$22.97
P9638		LP400-015	1-1/2"	60	0	\$10.65
P9390		LP400-020	2"	35	0	\$15.69
P9529		LP400-030	3"	15	0	\$41.30
P9530		LP400-040	4"	5	0	\$75.88

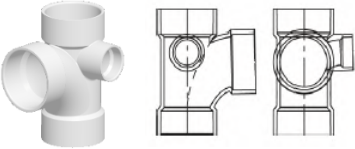
		LP400-060	6"	3	0	\$304.67	
		LP400-080	8"	2	0	\$675.02	
	Reducing Sanitary Tee(ALL HUB)	LP401-212	1-1/2×1-1/2×1-1/4"	10	40	\$19.47	
P9637		LP401-241	2×1-1/2×1-1/2"	15	60	\$13.81	
P9531		LP401-251	2×2×1-1/2"	50	0	\$13.85	
P9953		LP401-257	2×1-1/2×2"	15	60	\$16.76	
P9392		LP401-337	3×3×1-1/2"	8	32	\$30.18	
P9532		LP401-338	3×3×2"	15	0	\$31.07	
		LP401-419	4×4×1-1/2"	10	0	\$79.55	
P9534		LP401-420	4×4×2"	10	0	\$65.28	
P9535		LP401-422	4×4×3"	10	0	\$88.74	
		LP401-528	6×6×2"	5	0	\$327.89	
		LP401-530	6×6×3"	4	0	\$359.98	
		LP401-532	6×6×4"	4	0	\$294.65	
P10017		Sanitary Tee, Street (S × H × H)	LP403-015	1-1/2"	25	100	\$32.15
P11874			LP403-020	2"	30	0	\$31.18
P10692	LP403-030		3"	10	0	\$51.98	
P10019	LP403-040		4"	10	0	\$131.25	
	Sanitary Tee, Street, Reducing (S × H × H)	LP404-241	2×1-1/2×1-1/2"	50	0	\$26.70	
		LP404-257	2×1-1/2×2"	15	60	\$24.48	
		LP404-251	2×2×1-1/2"	15	60	\$27.48	
		LP404-337	3×3×1-1/2"	9	36	\$59.81	
		LP404-338	3×3×2"	15	0	\$51.35	
		LP404-420	4×4×2"	10	0	\$97.55	
	Sanitary Tee w/ Left Side Inlet (ALL HUB)	LP416-337	3×3×3×1-1/2"	8	0	\$112.03	
		LP416-338	3×3×3×2"	10	0	\$74.75	
		LP416-420	4×4×4×2"	4	0	\$180.26	
	Sanitary Tee w/ Right Side Inlet (ALL HUB)	LP417-337	3×3×3×1-1/2"	10	0	\$108.23	
		LP417-338	3×3×3×2"	12	0	\$74.75	
		LP417-420	4×4×4×2"	8	0	\$180.26	

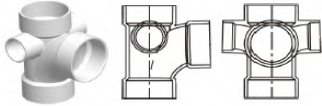
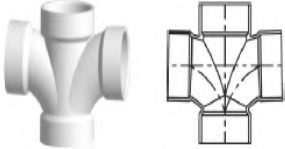
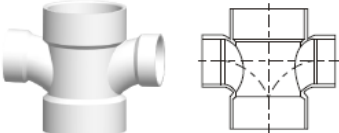
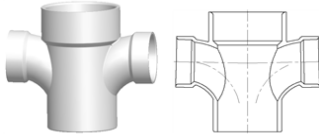
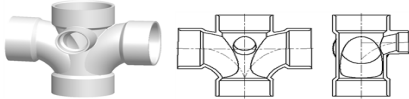

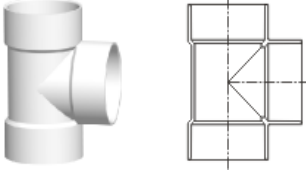
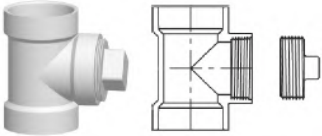
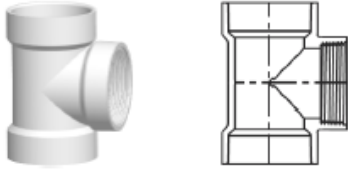
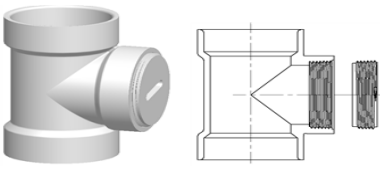
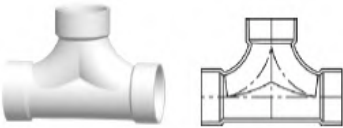
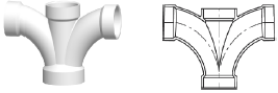

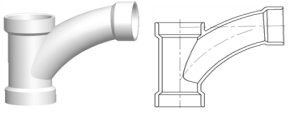
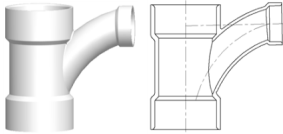
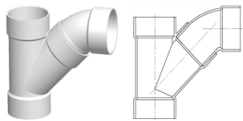
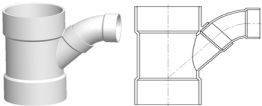
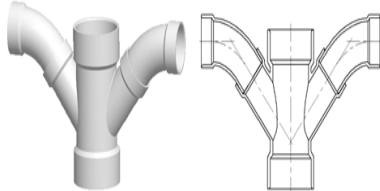

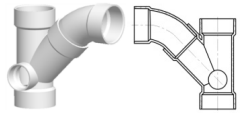
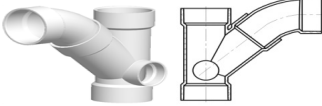
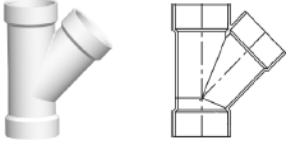
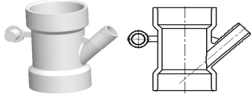
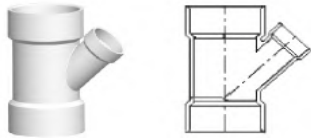
	Sanitary Tee w/ R & L Side Inlets (ALL HUB) 	LP418-337	3×3×3×1-1/2×1-1/2"	6	0	\$82.11
		LP418-338	3×3×3×2×2"	6	0	\$118.59
		LP418-420	4×4×4×2×2"	5	0	\$215.83
P10095	Double Sanitary Tee (ALL HUB) 	LP428-015	1-1/2"	15	60	\$23.62
P9971		LP428-020	2"	25	0	\$31.93
P10953		LP428-030	3"	6	0	\$89.25
P9906		LP428-040	4"	6	0	\$143.55
		LP428-060	6"	1	0	\$658.06
P10815	Double Sanitary Tee, Reducing (ALL HUB) 	LP429-251	2×2×1-1/2×1-1/2"	25	0	\$25.06
		LP429-323	3×3×2×1-1/2"	25	0	\$49.98
		LP429-337	3×3×1-1/2×1-1/2"	6	24	\$53.10
P9746		LP429-338	3×3×2×2"	10	0	\$57.75
		LP429-419	4×4×1-1/2×1-1/2"	7	0	\$191.42
P9693		LP429-420	4×4×2×2"	5	0	\$118.73
P10088		LP429-422	4×4×3×3"	5	0	\$123.20
		LP429-528	6×6×2×2"	4	0	\$474.98
		LP429-530	6×6×3×3"	4	0	\$497.62
	LP429-532	6×6×4×4"	3	0	\$516.68	
	Double Sanitary Tee, Street, Reducing (S × H × H × H) 	LP431-338	3×3×2×2"	10	0	\$189.02
	Double Sanitary Tee w/ Side Inlet (All HUB) 	LP438-337	3×3×3×3×1-1/2"	5	0	\$125.49
			3×3×3×3×2"	5	0	\$125.64
		LP438-420	4×4×4×4×2"	4	0	\$267.30
	Double Sanitary Tee w/ R & L Side Inlets (All HUB)	LP439-338	3×3×3×3×2×2"	4	0	\$176.11

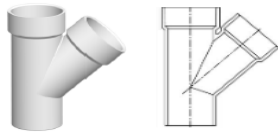
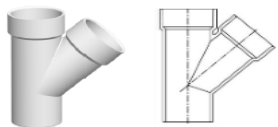
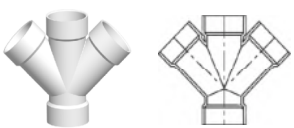
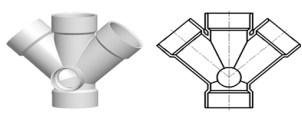
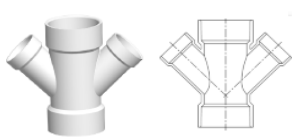
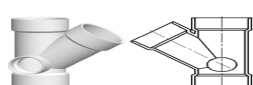

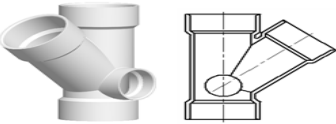

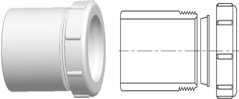
		LP439-420	4x4x4x4x2x2"	4	0	\$289.55
	Vent Tee (ALL HUB)	LP441-015	1-1/2"	25	100	\$39.88
P11831		LP441-020	2"	25	0	\$32.68
		LP441-030	3"	10	0	\$95.19
		LP441-040	4"	5	0	\$130.27
		LP441-060	6"	3	0	\$260.91
		LP441-080	8"	5	0	\$672.00
P10077		Cleanout Tee w/ C.O. Plug (H x H)	LP444X-015	1-1/2"	20	80
P9674		LP444X-020	2"	15	60	\$31.18
P9732		LP444X-030	3"	20	0	\$59.68
P9735		LP444X-040	4"	10	0	\$103.19
		LP444X-060	6"	4	0	\$495.24
		LP444X-080	8"	4	0	\$904.90
		Flush C.O. Tee (H x H x FPT)	LP445-015	1-1/2"	20	120
		LP445-020	2"	20	80	\$25.44
		LP445-030	3"	15	0	\$49.32
P11062		LP445-040	4"	10	0	\$88.02
		LP445-060	6"	6	0	\$442.60
		LP445-080	8"	4	0	\$726.14
P11511		Flush C.O. Tee w/C.O. Plug (H x H x FPT)	LP445X-020	2"	10	60
		LP445X-030	3"	10	0	\$69.27
P11510		LP445X-040	4"			\$114.53
	2-Way Cleanout (ALL HUB)	LP448-030	3"	10	0	\$95.63
		LP448-040	4"	4	0	\$123.77
P10715	Double Fixture Fitting (ALL HUB)	LP500-020	2x2x2x2"	15	0	\$54.33
		LP500-030	3x3x3x3"	10	0	\$117.27
		LP500-241	2x1-1/2x1-1/2x1-1/2"	20	0	\$66.86

		LP500-251	2×2×1-1/2×1-1/2"	20	0	\$62.46
		LP500-257	2×1-1/2×2×2"	20	0	\$43.35
		LP500-338	3×2×3×3"	10	0	\$130.17
	Combination Wye and 1/8 Bend (One Piece) (All HUB) 	LP501-015	1-1/2"	10	40	\$26.00
		LP501-020	2"	20	0	\$27.61
		LP501-030	3"	10	0	\$71.04
		LP501-040	4"	4	0	\$140.77
	Combination Wye and 1/8 Bend, Reducing (One Piece) (All HUB) 	LP502-241	2×1-1/2×1-1/2"	10	40	\$49.81
		LP502-251	2×2×1-1/2"	10	40	\$36.54
		LP502-257	2×1-1/2×2"	20	0	\$34.80
		LP502-337	3×3×1-1/2"	12	0	\$65.16
		LP502-338	3×3×2"	12	0	\$48.54
		LP502-420	4×4×2"	6	0	\$73.54
		LP502-422	4×4×3"	4	0	\$94.87
	Combination Wye and 1/8 Bend (Two Piece) (All HUB) 	LP503-015	1-1/2"			\$23.31
		LP503-020	2"			\$28.41
		LP503-030	3"	10	0	\$75.11
		LP503-040	4"	5	0	\$175.54
		LP503-060	6"	1	0	\$542.02
		LP503-080	8"			\$789.69
	Combination Wye and 1/8 Bend, Reducing (Two Piece) (All HUB) 	LP504-338	3x3x2"			\$75.94
		LP504-422	4x4x3"			\$140.58
		LP504-532	6×6×4"	3	0	\$487.50
		LP504-582	8x8x3"			\$460.45
		LP504-585	8x8x6"			\$783.03
		LP504-624	10x10x4"			\$791.21
	Combination Wye and 1/8 Bend Double Assembly (All HUB) 	LP507-015	1-1/2"	10	0	\$82.44
		LP507-020	2"	10	0	\$127.76
		LP507-030	3"	6	0	\$181.94
		LP507-040	4"	3	0	\$368.73
		LP507-251	2×1-1/2"	30	0	\$122.99
		LP507-338	3×2"	10	0	\$208.55
P11260						

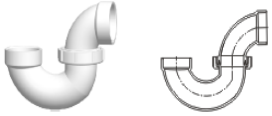
		LP507-420	4x2"	5	0	\$388.75	
		LP507-422	4x3"	5	0	\$340.21	
	Combination Wye and 1/8 Bend w/Left Side Inlet (All HUB) 	LP515-338	3x3x3x2"	8	0	\$210.81	
	Combination Wye and 1/8 Bend w/Right Side Inlet (All HUB) 	LP516-338	3x3x3x2"	8	0	\$210.81	
	Wye (ALL HUB)	LP600-012	1-1/4"	25	100	\$29.33	
P9639		LP600-015	1-1/2"	50	0	\$19.53	
P9553		LP600-020	2"	25	0	\$19.12	
P9497		LP600-030	3"	15	0	\$51.59	
P9498		LP600-040	4"	8	0	\$93.84	
P11232		LP600-060	6"	2	0	\$272.46	
		LP600-080	8"	2	0	\$480.36	
		Dishwasher Wye (H x H x Hose Barb) 	LP601-209	1-1/2"x1-1/2"x1/2"	40	160	\$5.16
		Reducing Wye (ALL HUB)	LP601-241	2x1-1/2x1-1/2"	15	60	\$26.89
P10020		LP601-251	2x2x1-1/2"	15	60	\$23.53	
P11489		LP601-257	2x1-1/2x2"	10	40	\$41.65	
P9784		LP601-337	3x3x1-1/2"	15	0	\$34.79	
P9636		LP601-338	3x3x2"	12	0	\$38.17	
P10100		LP601-419	4x4x1-1/2"	10	0	\$120.33	
P9537		LP601-420	4x4x2"	10	0	\$56.49	
P9538		LP601-422	4x4x3"	10	0	\$76.17	
		LP601-528	6x6x2"	5	0	\$286.00	
		LP601-530	6x6x3"	3	0	\$264.70	
P11357		LP601-532	6x6x4"	4	0	\$206.81	
		LP601-582	8x8x4"	4	0	\$423.78	
		LP601-585	8x8x6"	2	0	\$452.55	

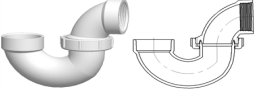
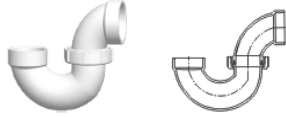
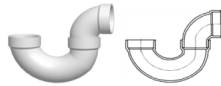
		LP601-624	10x10x4"	4	0	\$603.55
	Wye, Street(S × H × H)	LP602-015	1-1/2"	50	0	\$36.22
		LP602-020	2"	10	40	\$34.73
		LP602-030	3"	10	0	\$75.57
		LP602-040	4"	8	0	\$154.74
	Wye, Street, Reducing(S × H × H)	LP603-251	2×2×1-1/2"	15	60	\$44.55
		LP603-337	3×3×1-1/2"	15	0	\$84.82
		LP603-338	3×3×2"	8	0	\$59.40
		LP603-420	4×4×2"	5	0	\$176.64
		LP603-422	4×4×3"	5	0	\$164.61
P11324	Double Wye (ALL HUB)	LP611-015	1-1/2"	40	0	\$43.96
P10870		LP611-020	2"	20	0	\$49.04
P9907		LP611-030	3"	8	0	\$102.01
P10762		LP611-040	4"	5	0	\$206.67
		LP611-060	6"	1	0	\$410.98
	Double Wye, w/2" Side Inlet (ALL HUB)	LP611S-030	3"×3"×3"×3"×2"	10	0	\$579.86
						
P10816	Reducing Double Wye(ALL HUB)	LP612-251	2×2×1-1/2×1-1/2"	10	40	\$44.81
		LP612-337	3×3×1-1/2×1-1/2"	10	0	\$89.34
P10680		LP612-338	3×3×2×2"	15	0	\$76.03
P9745		LP612-420	4×4×2×2"	6	0	\$124.09
P11372		LP612-422	4×4×3×3"	5	0	\$163.88
		LP612-528	6×6×2×2"	4	0	\$389.17
		LP612-530	6×6×3×3"	3	0	\$402.83
		LP612-532	6×6×4×4"	3	0	\$575.05
	Wye w/Left Side Inlet (All HUB)	LP625-338	3×3×3×2"	18	0	\$235.51
		LP625-420	4×4×4×2"	4	0	\$313.41

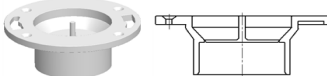
	Wye w/Right Side Inlet (All HUB)	LP626-338	3×3×3×2"	6	0	\$235.51
		LP626-420	4×4×4×2"	3	0	\$313.41
	Adapter, Tail Piece body w/Plastic Nut (S x SLIP)	LP704-015	1-1/2"	24	144	\$8.71
						
	Adapter, Tail Piece w/Plastic Nut (S x SLIP)	LP704P-015	1-1/2"	24	144	\$11.62
		LP704P-212	1-1/2×1-1/4"	20	120	\$11.62
P10738	Return Bend (H × H)	LP700-015	1-1/2"	20	80	\$18.33
P11118		LP700-020	2"	25	0	\$31.50
P9884		LP700-030	3"	8	0	\$97.71
P10822		LP700-040	4"	6	0	\$177.46
		LP700-060	6"	2	0	\$381.27
P9882	P-Trap (H × H)	LP706X-015	1-1/2"	25	0	\$20.48
P9642		LP706X-020	2"	15	0	\$27.58
P9691		LP706X-030	3"	10	0	\$93.78
P10673		LP706X-040	4"	4	0	\$212.31
		LP706X-060	6"	1	0	\$659.72
P10021	P-Trap w/ Cleanout (H × H)	LP707X-015	1-1/2"	30	0	\$34.85
P10022		LP707X-020	2"	20	0	\$57.04
	Adjustable P-Trap w/ Plastic Nut (H × H)	LP708P-012	1-1/4"	30	0	\$150.26
P9626		LP708P-015	1-1/2"	30	0	\$27.12
P9625		LP708P-020	2"	20	0	\$56.52

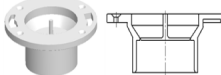
	P-TRAP W/UNION JOINT(H X FPT) 	LP709-015	1-1/2"	30	0	\$27.16
	P-Trap ,Low Profile(H x H) 	LP710-015	1-1/2"	25	0	\$13.02
		LP710-020	2"	15	0	\$23.38
		LP710-030	3"	10	0	\$93.80
		LP710-040	4"	4	0	\$213.95
		LP710-060	6"	1	0	\$659.72
P9957	L.A. Pattern P-Trap ,w/Union & 1-1/2 & 1-1/4 SLIP Washers ,w/Plastic Nut (SLIP×H)	LP711P-169	1-1/4×1-1/2"	30	0	\$45.70
P9987		LP711P-015	1-1/2"	30	0	\$46.47
	P-Trap(H x SLIP)	LP713-015	1-1/2"	25	0	\$41.83
	WASHER BOX P-TRAP (H X H) 	LP716-020	2"	20	0	\$27.05
P11422	Closet Flange (H) 	LP800-040	4×4"	30	0	\$25.71
P10008		LP800-422	4×3"	25	0	\$28.54
	Closet Flange (H) w/Test Plate 	LP800T-422	4×3"	20	0	\$27.80
P10696	Closet Flange, Reducing (SPIGOT) 	LP801-422	4×3"	25	0	\$29.56
	CLOSET FLANGE W/ ADJUSTABLE PLASTIC RING (S)	LP812P-422	4×3"	25	0	\$89.10
	Closet Flange(FPT) 	LP830-422	4×3"	20	0	\$39.03

	Closet Flange (MPT)	LP831-422	4×3"	25	0	\$29.93
	Tube End Cleanout w/ C.O. Plug (H × FPT) 	LP905X-015	1-1/2"	25	150	\$10.26
		LP905X-020	2"	25	100	\$14.40
		LP905X-030	3"	20	80	\$26.54
		LP905X-040	4"	24	0	\$55.16
	Closet Flange w/Adjustable metal ring (Epoxy Coated) (H) 	LP811-422	4×3"	0	20	\$66.82
		LP811-040	4×4"	0	20	\$82.96
	Closet Flange w/Adjustable metal ring (Epoxy Coated) (S) 	LP812-422	4×3"	0	36	\$66.51
		LP812-040	4×4"	0	30	\$79.60
	Offset Closet Flange W/Adjustable Metal Ring (Epoxy Coated) (H) 	LP820-422	4×3"	0	24	\$95.25
		LP820-040	4×4"	0	16	\$113.98
	Offset Closet Flange W/Adjustable Plastic Ring (H) 	LP820P-422	4×3"	0	24	\$129.75